

Precision Automotive Thin Film Chip Resistors, AEC-Q200 Qualified, 2 kV ESD Rating

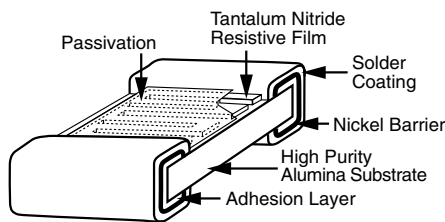

These chip resistors are available in wraparound terminations styles in 8 case sizes. They incorporate self passivated enhanced tantalum nitride resistor film to give superior performance on moisture resistance, electrostatic discharge, voltage coefficient, power handling and resistance stability. The terminations consist of an adhesion layer, a leach resistant nickel barrier, and solder coating (lead (Pb)-free). This product will out-perform all requirements of AEC-Q200.

CONSTRUCTION



FEATURES

- Resistance range: 2.5 Ω to 3 M Ω
- AEC-Q200 qualified
- AEC-Q200 ESD rated class 1C (2 kV)
- Laser trimmed to any value
- Moisture resistant to MIL-STD-202, method 202
- Tantalum nitride resistor film on high purity alumina substrate
- 100 % visual inspected per MIL-PRF-55342
- Laser-trimmed tolerances to ± 0.1 %
- Load life stability < 0.05 % at 1000 h at 70 $^{\circ}$ C
- Very low noise and voltage coefficient (< -30 dB, < 0.1 ppm/V)
- Sulfur resistant (per ASTM B809-95 humid vapor test)
- Material categorization: for definitions of compliance please see www.vishay.com/doc?99912



RoHS
COMPLIANT
HALOGEN
FREE
GREEN
(5-2008)

TYPICAL PERFORMANCE

	ABSOLUTE
■	
TCR	25
TOL.	0.1

STANDARD ELECTRICAL SPECIFICATIONS

TEST	SPECIFICATIONS	CONDITIONS
Material	Tantalum nitride	-
Resistance Range	2.5 Ω to 3 M Ω	-
TCR: Absolute	± 25 ppm/ $^{\circ}$ C to ± 100 ppm/ $^{\circ}$ C	-55 $^{\circ}$ C to +125 $^{\circ}$ C
Tolerance: Absolute	± 0.1 % to ± 1.0 %	+25 $^{\circ}$ C
Stability: Absolute	± 0.05 %	2000 h at 70 $^{\circ}$ C rated power
Stability: Ratio	Not applicable	-
Voltage Coefficient	Less than 0.1 ppm/V	-
Working Voltage	75 V to 200 V	-
Operating Temperature Range	-55 $^{\circ}$ C to +155 $^{\circ}$ C	-
Storage Temperature Range	-55 $^{\circ}$ C to +155 $^{\circ}$ C	-
Noise	< -30 dB	-
Shelf Life Stability: Absolute	100 ppm	1 year at 25 $^{\circ}$ C

COMPONENT RATINGS

CASE SIZE	POWER RATING (mW)	WORKING VOLTAGE (V)	RESISTANCE RANGE (Ω)
0402	50	75	20 to 51K
0603	150	75	2.5 to 130K
0805	200	100	10 to 301K
1206	400	200	10 to 1M
1505	400	150	10 to 1M
2208	750	150	10 to 1.75M
2010	800	200	10 to 2M
2512	1000	200	10 to 3M

DIMENSIONS in inches					
CASE SIZE	L	W	T	D	E
0402	0.042 ± 0.008	0.022 ± 0.005	0.015 ± 0.003	0.010 ± 0.005	0.010 ± 0.005
0603	0.064 ± 0.006	0.032 ± 0.005	0.015 ± 0.003	0.012 ± 0.005	0.015 ± 0.005
0805	0.080 ± 0.006	0.050 ± 0.005	0.015 ± 0.003	0.015 ± 0.005	0.015 ± 0.005
1206	0.126 ± 0.008	0.063 ± 0.005	0.015 ± 0.003	0.020 + 0.005 / - 0.010	0.020 + 0.005 / - 0.010
1505	0.155 ± 0.007	0.050 ± 0.005	0.015 ± 0.003	0.015 ± 0.005	0.015 ± 0.005
2010	0.209 ± 0.009	0.098 ± 0.005	0.015 ± 0.003	0.020 ± 0.005	0.020 ± 0.005
2208	0.230 ± 0.007	0.075 ± 0.005	0.015 ± 0.003	0.020 ± 0.005	0.020 ± 0.005
2512	0.259 ± 0.009	0.124 ± 0.005	0.015 ± 0.003	0.020 ± 0.005	0.020 ± 0.005

ENVIRONMENTAL TESTS (Vishay Performance vs. AEC-Q200 Requirements)				
ENVIRONMENTAL TEST		CONDITIONS	LIMITS PER AEC-Q200	TYPICAL VISHAY PERFORMANCE
Resistance Temperature Characteristic		-55 °C to +125 °C	± 50 ppm/°C	± 35 ppm/°C
Max. Ambient Temp. at Rated Wattage			+70 °C	+70 °C
Max. Ambient Temp. at Power Derating			+150 °C	+150 °C
High Temperature Storage	ΔR	MIL-STD-202, 108, 1000 h at 125 °C	± 0.1 %	+ 0.016 %
Temperature Cycling	ΔR	JESD22, JA-104, 1000 cycles, -55 °C to +125 °C	± 0.15 %	+ 0.013 %
Moisture Resistance	ΔR	MIL-STD-202, 106	± 0.20 %	+ 0.0010 %
Biased Humidity	ΔR	MIL-STD-202, 103, 1000 h at 85 °C, 85 % RH, 10 % P	± 0.10 %	+ 0.004 %
Life	ΔR	MIL-STD-202, 108 at 125 °C, 1000 h	± 0.1 %	+ 0.0220 %
Mechanical Shock	ΔR	MIL-STD-202, method 213, condition C	± 0.1 %	+ 0.004 %
Vibration	ΔR	MIL-STD-202 method 204, 10 Hz to 2 kHz	± 0.1 %	+ 0.0030 %
Resistance to Soldering Heat	ΔR	MIL-STD-202 method 210, condition D	± 0.10 %	+ 0.0150 %
Electrostatic Discharge	ΔR	AEC-Q200-002 at 2 kV, human body	± 0.10 %	- 0.032 %
Solderability	Visual	J-STD-002, method B and B1	95 %	Acceptable
Terminal Strength	ΔR	AEC-Q200-006 at 1 kg for 60 s	± 0.10 %	+ 0.009 %
Flame Retardance	Visual	AEC-Q200-001 para 4.0		Acceptable





GLOBAL PART NUMBER INFORMATION															
New Global Part Numbering: PAT1206E1002BST1															
P	A	T	1	2	0	6	E	1	0	0	2	B	S	T	1
GLOBAL MODEL	CASE SIZE	TCR CHARACTERISTIC		RESISTANCE		TOLERANCE		TERMINATION		PACKAGING					
PAT	0402 0603 0805 1206 1505 2010 2208 2512	E = ± 25 ppm/°C H = ± 50 ppm/°C K = ± 100 ppm/°C L = ± 200 ppm/°C		The first 3 digits are significant figures and the last digit specifies the number of zeros to follow. "R" designates the decimal point. Example: 10R0 = 10 Ω 1000 = 100 Ω 1002 = 10 kΩ		B = ± 0.1 % D = ± 0.5 % F = ± 1.0 % G = ± 2.0 % J = ± 5.0 %		S = wraparound lead (Pb)-free solder w/nickel barrier		TAPE AND REEL T1 = 1000 min., 1000 mult ⁽¹⁾ TF = full reel TS = 100 min., 1 mult					

Note

(1) Preferred packaging code

RESISTANCE	TCR (ppm/°C)	TOLERANCE (%)
10 Ω to 1 MΩ	25, 50, 100, 200	0.1, 0.5, 1, 2, 5
5 Ω to 10 Ω	100, 200	1, 2, 5
1.0 Ω to 5 Ω	200	1, 2, 5



Vishay Dale Thin Film Land Patterns

1. Scope

This technical note provides sample land patterns for Vishay Dale Thin Film SMT resistive products. The following drawings are based on IPC-SM-782 Surface Mount Design and Land Pattern Standard. These drawings are for reference only Vishay Thin Film recommends that the user contacts their PC board supplier for actual land patterns required. The pads are intended for lead (Pb)-free and tin / lead solder types.

2. Product Series

Thin Film Surface Mount Chip Resistors (FC, L, P, PTN, PLT, PLTT, PLTU, PAT, PATT, PNM, M/D55342 QPL Series)

0402 Land Pattern

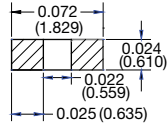

0502 Land Pattern

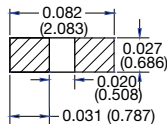

0505 Land Pattern

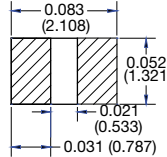

0603 Land Pattern

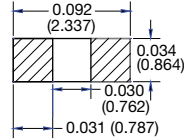

0705 Land Pattern

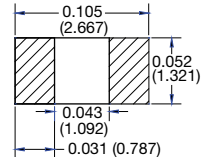

1005 Land Pattern

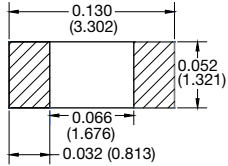

1010 Land Pattern

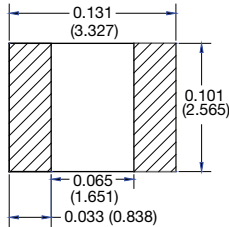

1206 Land Pattern

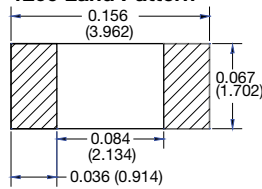

1505 Land Pattern

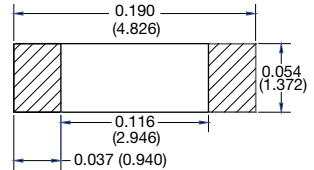

2010 Land Pattern

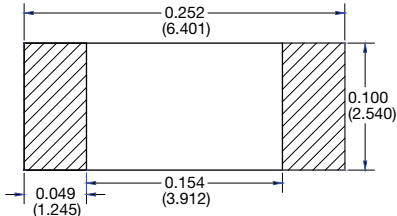

2208 Land Pattern

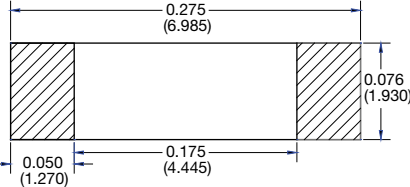

2512 Land Pattern

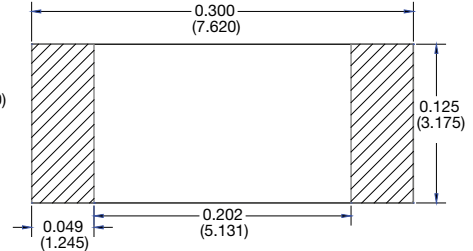



Thin Film Surface Mount Chip Resistors (PHP, PCAN Series)

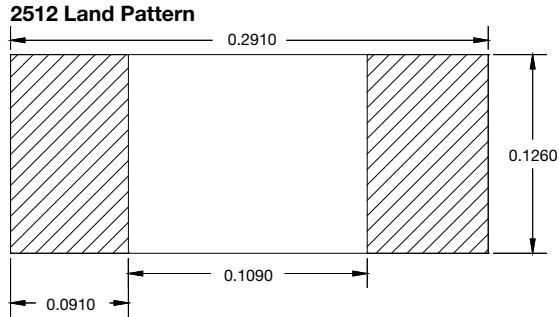
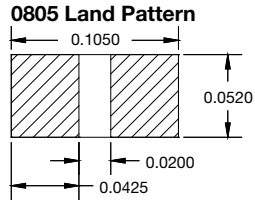
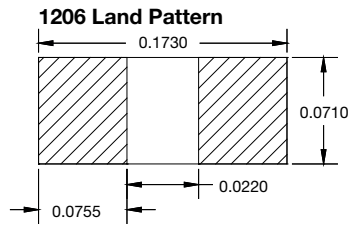
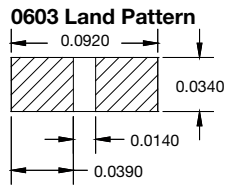

Thin Film Surface Mount Chip Resistors Long Axis Termination (L Series)

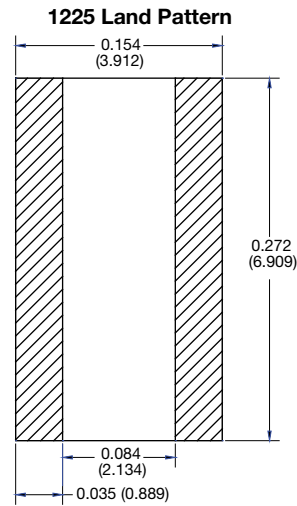
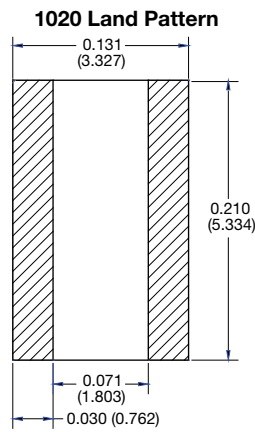
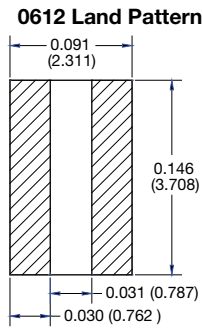
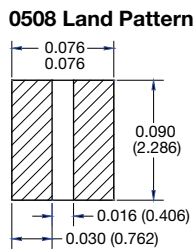



Surface Mount Networks (MPM, MP3, MP4 Series)

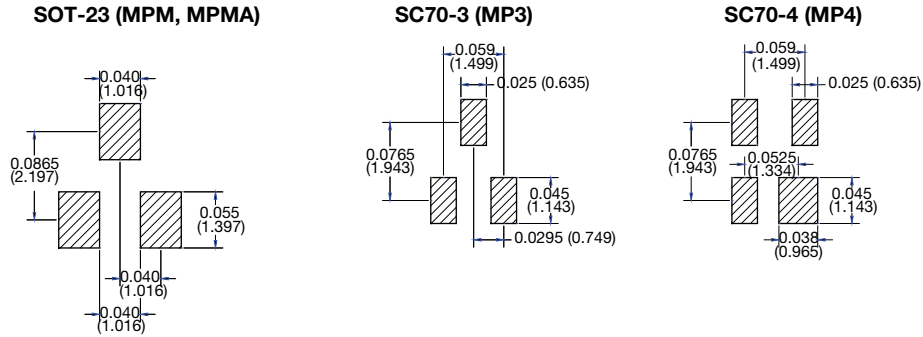

Surface Mount Networks SOIC Narrow Body 150 mils (ORN, CSO, MOMC, HTRN, AORN, MORN Series)

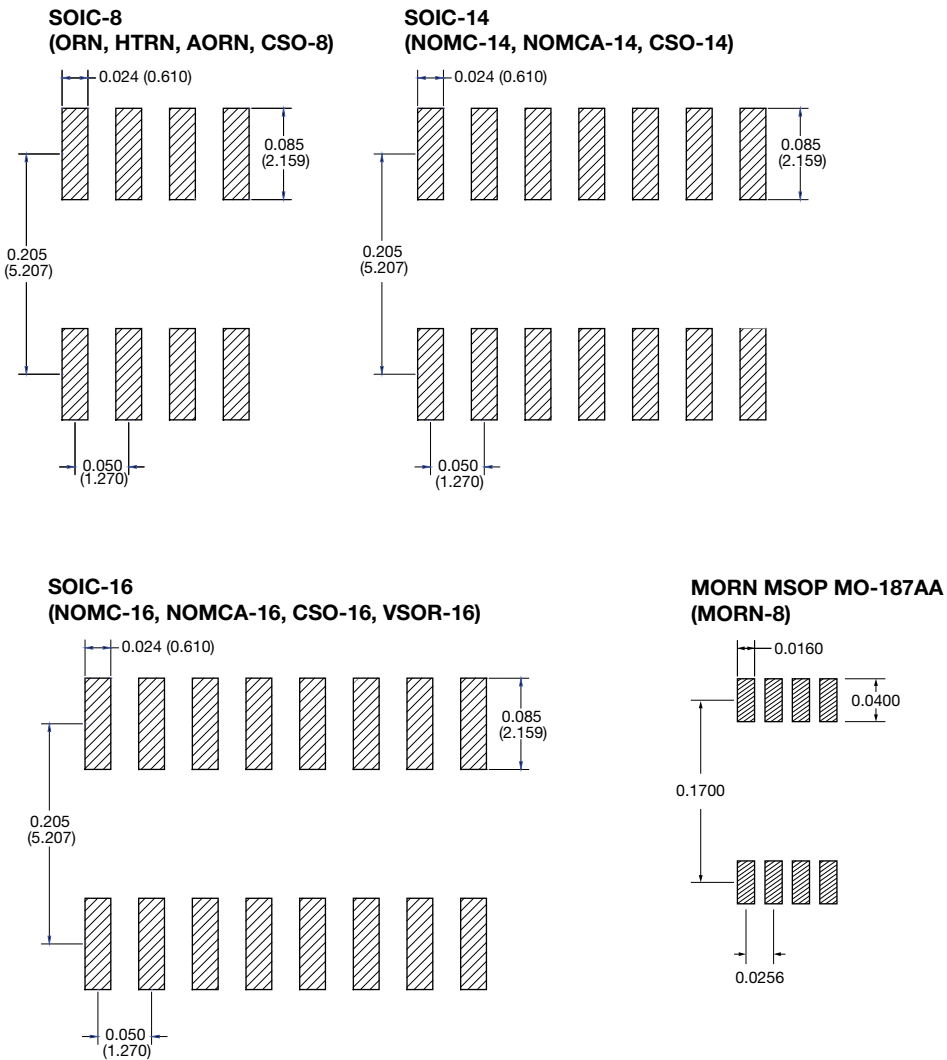



Surface Mount Networks SOIC Medium Body 220 mils (TOMC Series)

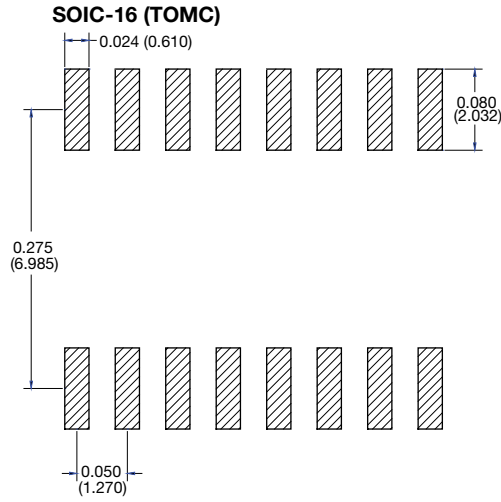

Surface Mount Networks SOIC Wide Body 300 mils (WOMC Series)

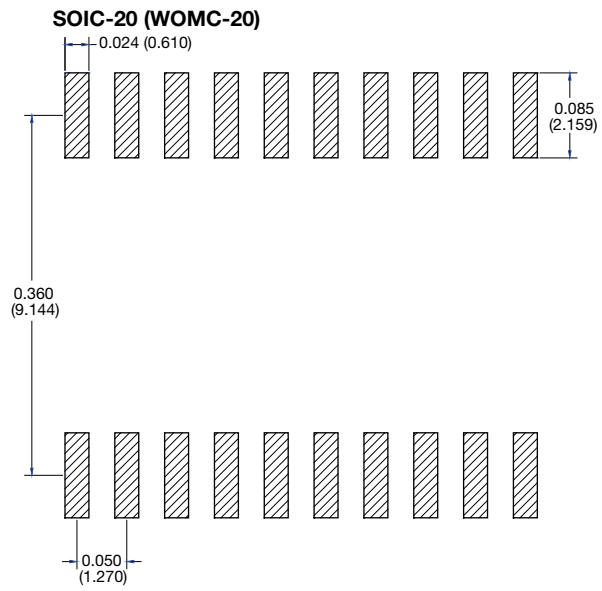
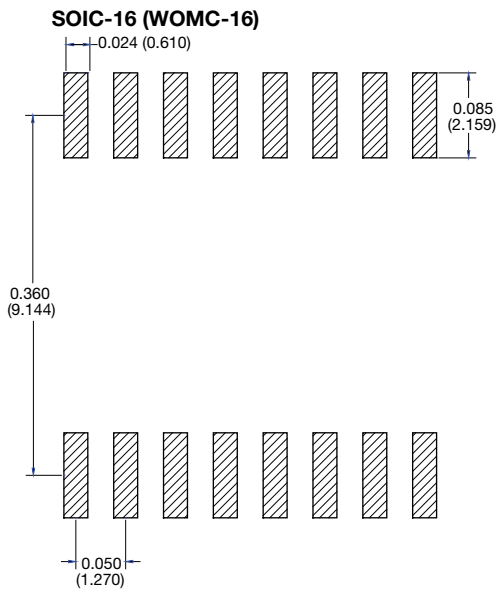



Surface Mount Networks High Density SSOP, TSOP (VSSR, VTSR Series)

SSOP MO-137

OSOP-16, VSSR-16

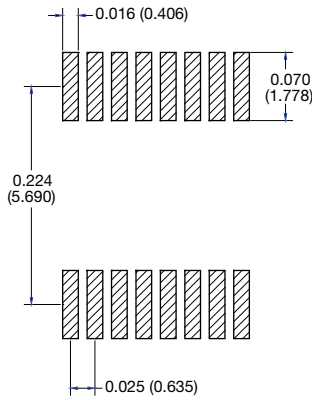

OSOP-20, VSSR-20

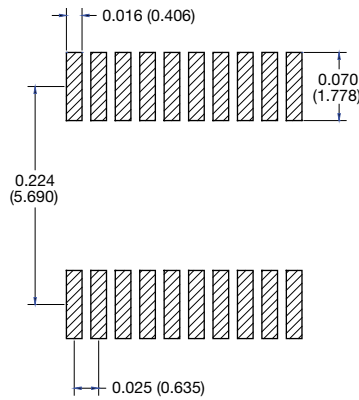

OSOP-24, VSSR-24, HD-CSO-24

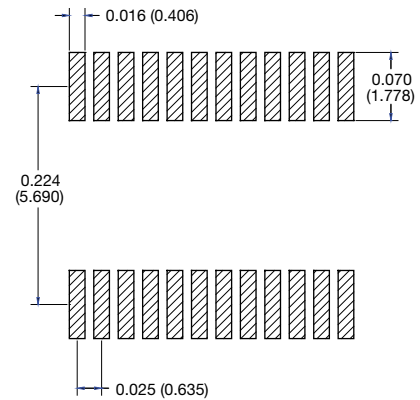

TSSOP MO-153

VTSR-16

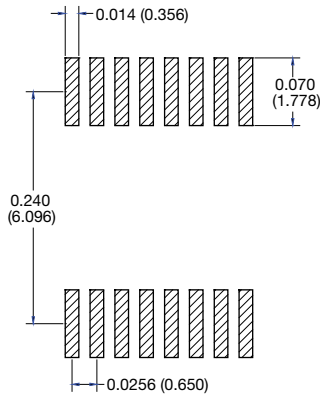

VTSR-20

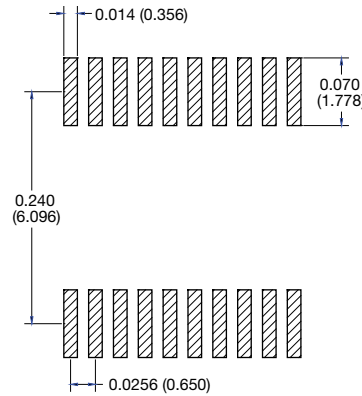

VTSR-24

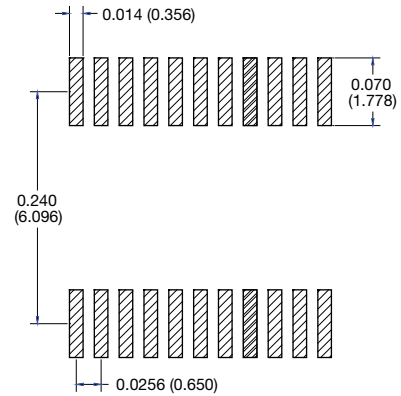

Surface Mount Leadless Networks (LCC Series)

16 Pin LCC

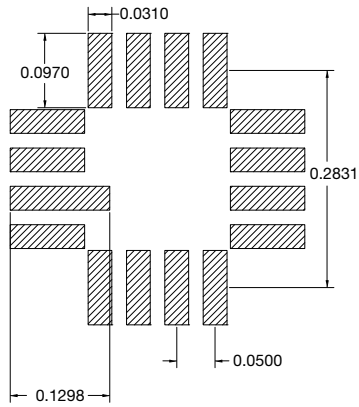

20 Pin LCC

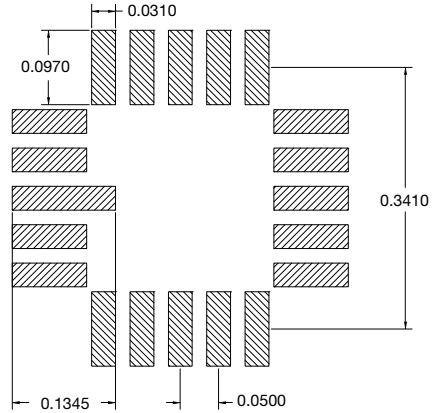

Surface Mount Leadless Networks (MPH Series)

4 Pin LCC

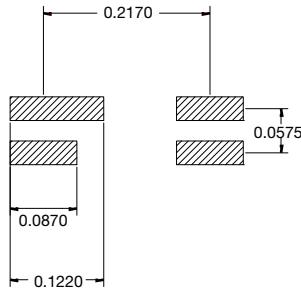

Surface Mount Leadless Packages DUAL/ QUAD Flat No Lead (DFN, QFN Series)

DFN MLP

DFN-8 4 x 5 mm Sq

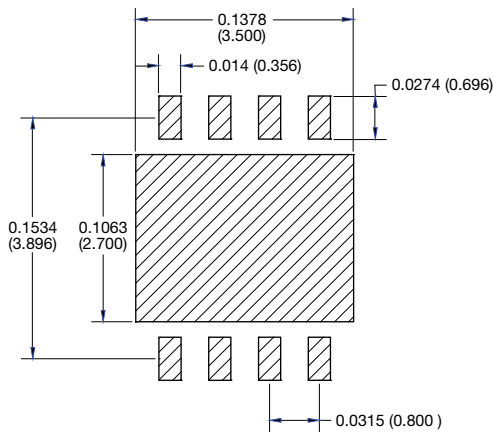

QFN MLP

QFN-20 5 x 5 mm Sq

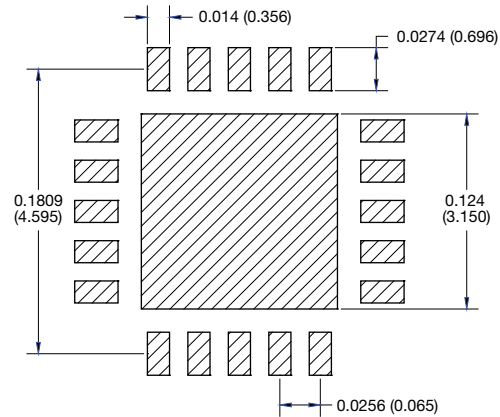

Surface Mount Leadless Resistor Arrays (PR Series)

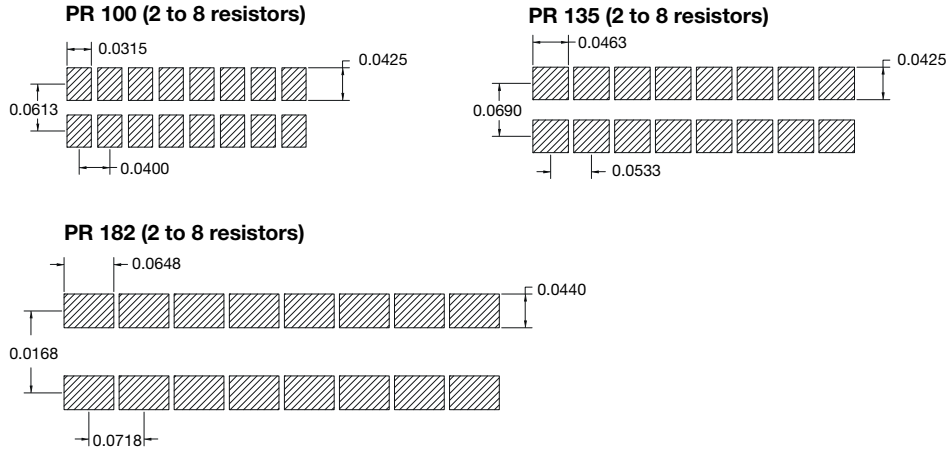

Note

- All dimensions in inches (mm)

Flatpack

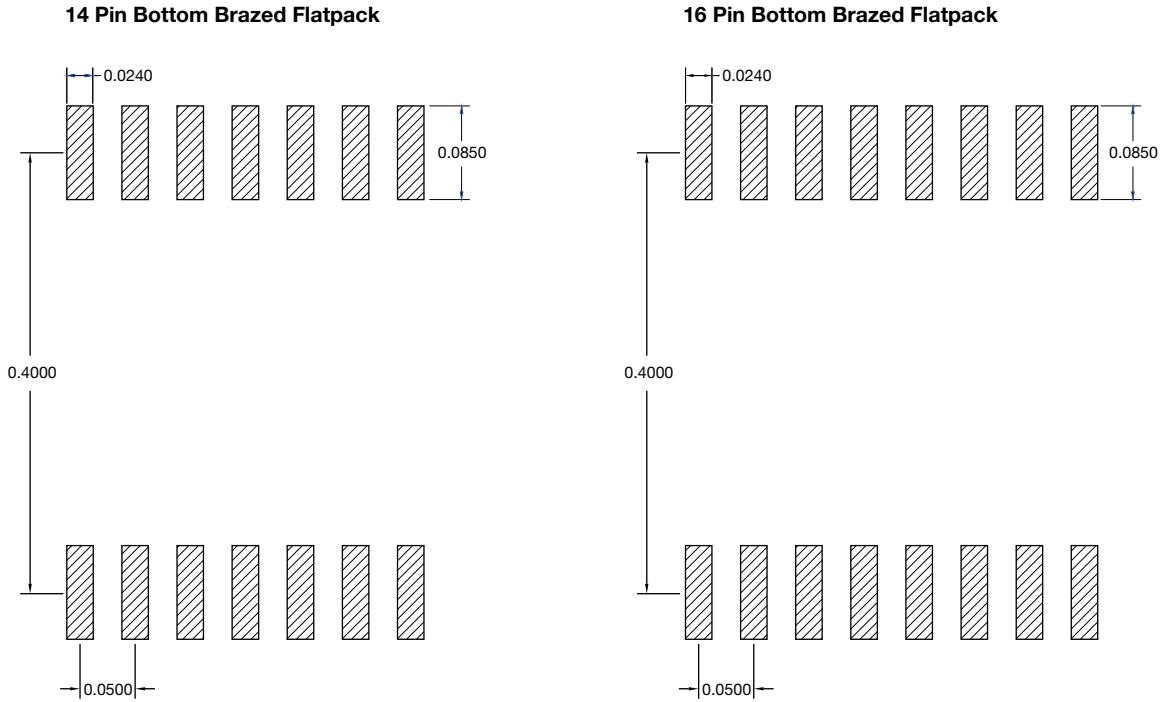



Disclaimer

ALL PRODUCT, PRODUCT SPECIFICATIONS AND DATA ARE SUBJECT TO CHANGE WITHOUT NOTICE TO IMPROVE RELIABILITY, FUNCTION OR DESIGN OR OTHERWISE.

Vishay Intertechnology, Inc., its affiliates, agents, and employees, and all persons acting on its or their behalf (collectively, "Vishay"), disclaim any and all liability for any errors, inaccuracies or incompleteness contained in any datasheet or in any other disclosure relating to any product.

Vishay makes no warranty, representation or guarantee regarding the suitability of the products for any particular purpose or the continuing production of any product. To the maximum extent permitted by applicable law, Vishay disclaims (i) any and all liability arising out of the application or use of any product, (ii) any and all liability, including without limitation special, consequential or incidental damages, and (iii) any and all implied warranties, including warranties of fitness for particular purpose, non-infringement and merchantability.

Statements regarding the suitability of products for certain types of applications are based on Vishay's knowledge of typical requirements that are often placed on Vishay products in generic applications. Such statements are not binding statements about the suitability of products for a particular application. It is the customer's responsibility to validate that a particular product with the properties described in the product specification is suitable for use in a particular application. Parameters provided in datasheets and / or specifications may vary in different applications and performance may vary over time. All operating parameters, including typical parameters, must be validated for each customer application by the customer's technical experts. Product specifications do not expand or otherwise modify Vishay's terms and conditions of purchase, including but not limited to the warranty expressed therein.

Except as expressly indicated in writing, Vishay products are not designed for use in medical, life-saving, or life-sustaining applications or for any other application in which the failure of the Vishay product could result in personal injury or death. Customers using or selling Vishay products not expressly indicated for use in such applications do so at their own risk. Please contact authorized Vishay personnel to obtain written terms and conditions regarding products designed for such applications.

No license, express or implied, by estoppel or otherwise, to any intellectual property rights is granted by this document or by any conduct of Vishay. Product names and markings noted herein may be trademarks of their respective owners.